

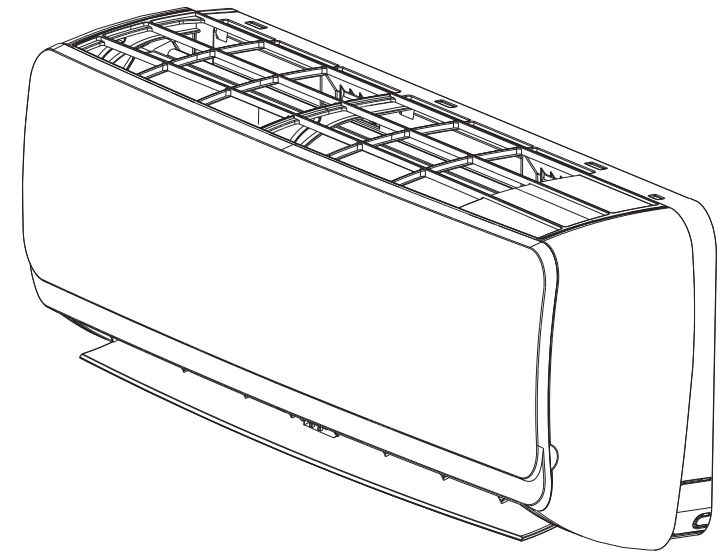

AIR CONDITIONER OWNER 'S MANUAL



1. 06. 09. 00000

Thank you for selecting super quality Air Conditioner. To ensure satisfactory operation for many years to come, this Owner's Manual should be read carefully before using your air conditioner. After reading, store it in a safe place. Please refer to the manual for questions on use or in the event that any irregularities occur. This Air Conditioner should be used for household use.

CONTENTS

Safety Precautions.....	1
Identification of Parts.....	2
Remote Controller.....	4
Operation instructions.....	6
Maintenance.....	8
Protection.....	9
Troubleshooting.....	10
Installation instructions.....	11

Preparation before use

Before using the air conditioner, be sure to check and preset the following.

- **Remote Controller presetting**

The remote controller is **NOT** presetting as Cooling Only Air Conditioner or Heat Pump by manufacturer.

Each time after the remote controller replaces batteries or is energized, the arrowhead will flash on the front of " Heat " or " Cool " on LCD of the remote controller.

User can preset the remote controller type depending on the air conditioner type you have purchased as follows:

Press any button when the arrowhead flashes on the front of " Heat ", Heat Pump is set.

Press any button when the arrowhead flashes on the front of " Cool ", Cooling Only is set.

If you don't press any button within 10 seconds, the remote controller is preset as Heat Pump automatically.

Note:

If the air conditioner you purchased is a Cooling Only one, but you preset the remote controller as Heat Pump, it doesn't bring any matter. But if the air conditioner you purchased is a Heat Pump one, and you preset the remote controller as Cooling Only, then you CAN NOT preset the Heating operation with the remote controller.

- **Auto-restart Presetting:**

the appliance is preset as no auto-restart function by manufacturer.If Auto-restart function is needed, follow the below step to activate this function:

- 1) Make sure air conditioner is turned off;
- 2) Press down and hold the Emergency button (ON/OFF)on the indoor unit until turning on the air conditioner.
- 3) Keep pressing the Emergency button for over 10s until three short beeps are heard.

Then Auto-restart function is activated. To cancel the Auto-restart function, repeat above procedure until four short beeps are heard.

Installation instructions

How to Purge Air Tubes:

- (1). Unscrew and remove caps from 2 and 3-way valves.
- (2). Unscrew and remove cap from service valve.
- (3). Connect vacuum pump flexible hose to the service valve.
- (4). Start vacuum pump for 10-15 minutes until reaching a vacuum of 10 mm Hg absolutes.
- (5). With vacuum pump still running close the low pressure knob on vacuum pump manifold. Then stop vacuum pump.
- (6). Open 2-way valve 1/4 turn then close it after 10 seconds. Check tightness of all joints using liquid soap or an electronic leak detector.
- (7). Turn 2 and 3-way valves stem to fully the valves. Disconnect vacuum pump flexible hose.
- (8). Replace and tighten all valve caps.



- Please read this manual before installing and using it.
- Do not let air enter the refrigeration system or discharge refrigerant when moving the air conditioner.
- Testing run the air conditioner after finishing installation, and record details of operation.
- Type of fuse used on indoor unit controller for 7K,9K,12K is 50T, with rating 3.15 A,T,250V. For 18K, 22K,24K models use 3.15A, T, 250V.
- The fuse for the whole unit is to be provided by the user according to the current at maximum power input or use other over-current protective device instead.
- Accessibility to the plug must be guaranteed even after the installation of the appliance to disconnect it in case of need. If not possible, connect appliance to a double-pole switching device with contact separation of at least 3 mm placed in an accessible position even after installation.

Installation instructions

Outdoor unit installation

1. Install Drain Port and Drain Hose (for heat-pump model only)

The condensate drains from the outdoor unit when the unit operates in heating mode. In order not to disturb your neighbor and protect the environment, install a drain port and a drain hose to direct the condensate water. Just install the drain port and rubber washer to the chassis of the outdoor unit, then connect a drain hose to the port as the right figure shown.

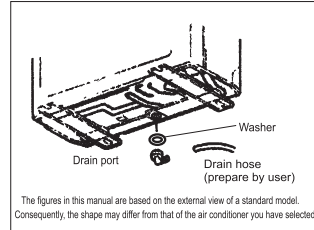

2. Install and Fix Outdoor Unit

Fix with bolts and nuts tightly on a flat and strong floor.

If installed on the wall or roof, make sure to fix the supporter well to prevent it from shaking due to serious vibration or strong wind.

3. Outdoor Unit Piping Connection

- Remove the valve caps from the 2-way and 3-way valve.
- Connect the pipes to the 2-way and 3-way valves separately according to the required torque.

4. Outdoor Unit Cable Connection (see previous page)

Air purging

The air which contains moisture remaining in the refrigeration cycle may cause a malfunction on the compressor. After connecting the indoor and outdoor units, evacuate air and moisture from refrigerant cycle using a vacuum pump, as shown below.

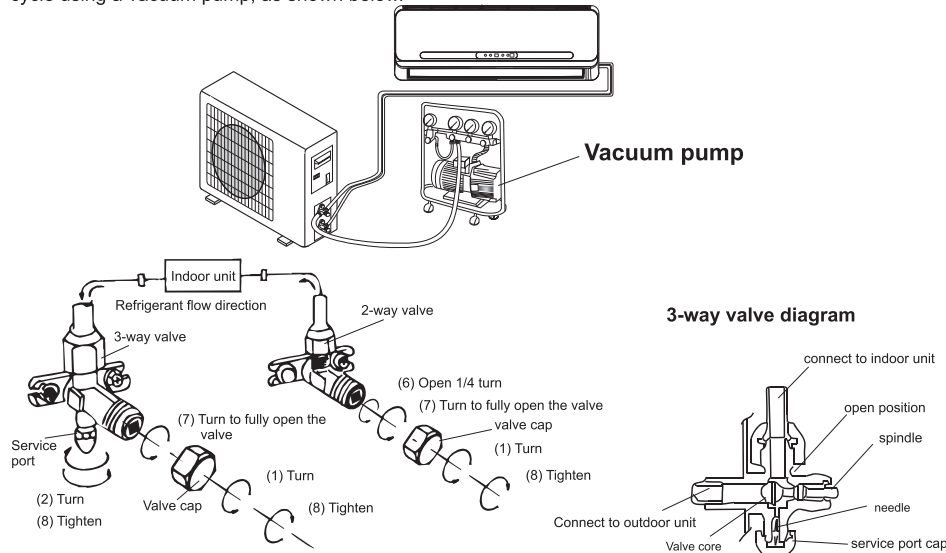

Note: To protect the environment, be sure not to discharge the refrigerant to the air directly.

Safety precautions

Symbols in this Use and Care Manual are interpreted as shown below.

- ⊘ Be sure not to do.
- ⚠ Be sure to follow this instruction.
- ❓ The feature of the appliance, instead of a fault.
- ⚡ Grounding is essential.
- ⚡ Pay attention to such a situation.
- ⚠ Warning: Incorrect handling could cause a serious hazard, such as serious injury, death, etc.

<p>Use correct power supply in accordance with the rating plate requirement. Otherwise, serious faults or hazard may occur or a fire maybe break out.</p>	<p>Keep the power supply circuit breaker or plug from dirt. Connect the power supply cord to it firmly and correctly, lest an electric shock or a fire break out due to insufficient contact.</p>	<p>Do not use the power supply circuit breaker or pull off the plug to turn it off during operation. This may cause a fire due to spark, etc.</p>
<p>Do not knit, pull or press the power supply cord, lest the power supply cord be broken. An electric shock or fire is probably caused by a broken power supply cord.</p>	<p>Never insert a stick or similar obstacle into the unit. Since the fan rotates at high speed, this may cause an injury.</p>	<p>It is harmful to your health if the cool air reaches you for a long time. It is advisable to let the air flow be deflected to the whole room.</p>
<p>Turn off the appliance by remote control firstly before cutting off power supply if malfunction occurs.</p>	<p>Do not repair the appliance by yourself. If this is done incorrectly, it may cause an electric shock, etc.</p>	<p>Prevent the air flow from reaching the gas burners and stove.</p>
<p>Do not touch the operation buttons when your hands are wet.</p>	<p>Do not put any objects on the outdoor unit.</p>	<p>It is the user's responsibility to make the appliance be grounded according to local codes or ordinances by a licenced technician.</p>

This appliance is not intended for use by persons (including children) with reduced physical, sensory or mental capabilities, or lack of experience and knowledge, unless they have been given supervision or instruction concerning use of the appliance by a person responsible for their safety. Children should be supervised to ensure that they do not play with the appliance.

If the supply cord is damaged, it must be replaced by the manufacturer, its service agent or similarly qualified persons in order to avoid a hazard.

The appliance shall be installed in accordance with national wiring regulations.

If connecting power to fixed wiring, an all-pole disconnection device which has at least 3mm clearances in all poles, and have a leakage current that may exceed 10mA, the residual current device(RCD) having a rated residual operating current not exceeding 30mA, and disconnection must be incorporated in the fixed wiring in accordance with the wiring rules.

Identification of parts

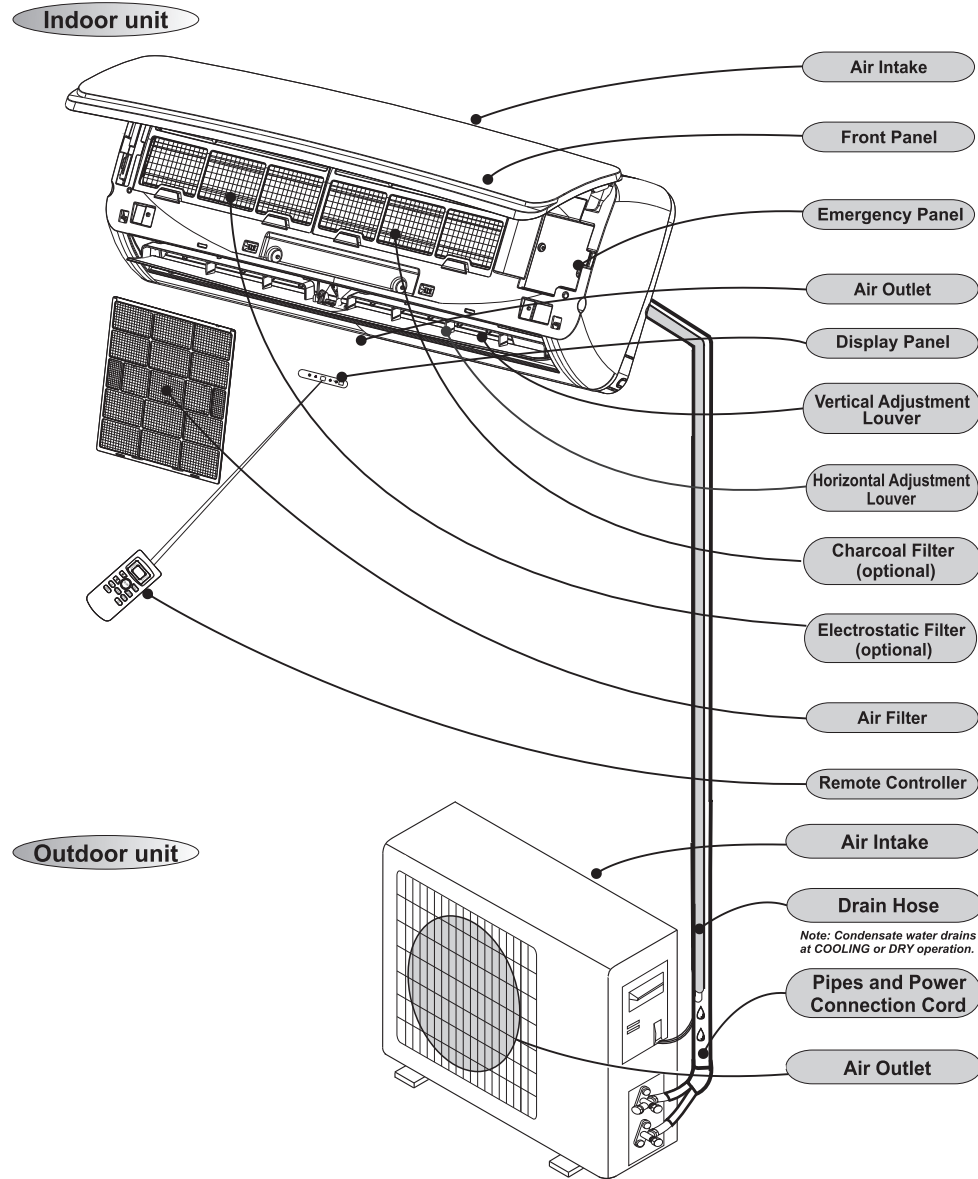

☑ The figures in this manual are based on the external view of a standard model. Consequently, the shape may differ from that of the air conditioner you have selected.

Installation instructions

4. Connecting of the Cable

• Indoor Unit

Connect the power connecting cord to the indoor unit by connecting the wires to the terminals on the control board individually in accordance with the outdoor unit connection.

Note: For some models, it is necessary to remove the cabinet to connect to indoor unit terminal.

• Outdoor Unit

1). Remove the access door from the unit by loosening the screw. Connect the wires to the terminals on the control board individually as the following.

2). Secure the power connecting cord onto the control board with cable clamp.

3). Reinstall the access door to the original position with the screw.

4) Use a recognized circuit breaker for 24K model between the power source and the unit. A disconnecting device to adequately disconnect all supply lines must be fitted.

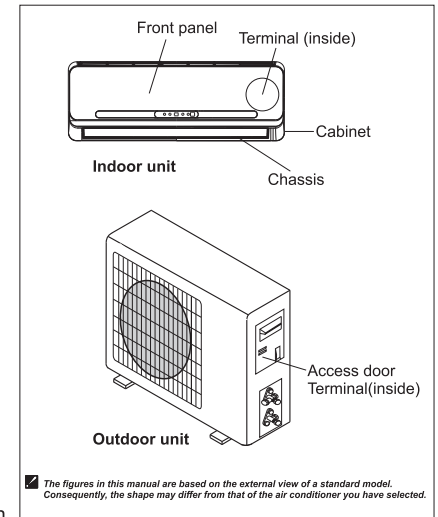

Caution:

1. Never fail to have an individual power circuit specifically for the air conditioner. As for the method of wiring, refer to the circuit diagram posted on the inside of the access door.

2. Confirm that the cable thickness is as specified in the power source specification. (See the cable specification table below)

3. Check the wires and make sure that they are all tightly fastened after cable connection.

4. Be sure to install an earth leakage circuit breaker in wet or moist area.

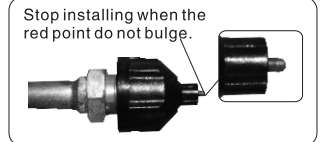

Cable Specifications

Capacity (Btu/h)	Power cord		Power connecting cord		Power connecting cord1(for heat pump)	
	Type	Normal cross-sectional area	Type	Normal cross-sectional area	Type	Normal cross-sectional area
7K,9K	H05VV-F	1.0mm ² X3	H07RN-F	1.0mm ² X3	H05RN-F	0.75mm ² X2
12K	H05VV-F	1.5mm ² X3	H07RN-F	1.5mm ² X3	H05RN-F	0.75mm ² X2
18K	H05VV-F	1.5mm ² X3 (2.5mm ² X3)	H07RN-F	1.5mm ² X3 (2.5mm ² X3)	H05RN-F	0.75mm ² X2
22K,24K	H05VV-F	2.5mm ² X3	H07RN-F	2.5mm ² X4	H05RN-F	0.75mm ² X2

Note: Above cables shall be approved by HAR or SAA.

Installation instructions

NOTE

- **Piping Joints Thermal Insulation:** Wrap the piping joints with thermal insulation materials and then wrap with a vinyl tape.

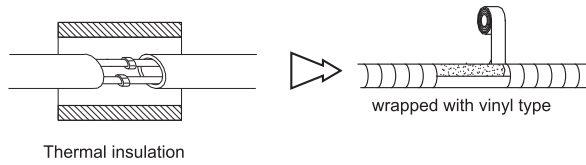

- **Piping Thermal Insulation:**

- Place the drain hose under the piping.
 - Insulation material uses polythene foam over 6mm in thickness.
- Note: Drain hose is prepared by user.**

- Drain pipe should point downward for easy drain flow. Do not arrange the drain pipe twisted, sticking out or wave around, do not immerse the end of it in water.

If an extension drain hose is connected to the drain pipe, make sure to thermal insulated when passing along the indoor unit.

- When the piping is directed to the right, piping, power Cord and drain pipe should be thermal insulated and fixed onto the back of the unit with a piping fixer.

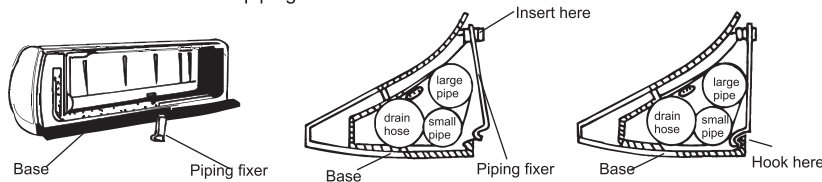
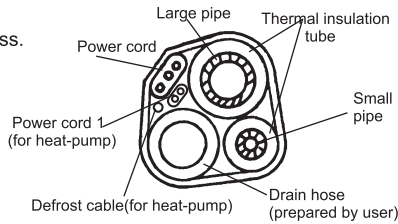

- Insert the pipe fixer to the slot.
- Press to hook the pipe fixer onto the base.

Piping Connection:

- Connect indoor unit pipes with two wrenches. Pay special attention to the allowed torque as shown below to prevent the pipes, connectors and flare nuts from being deformed and damaged.
- Pre-tighten them with fingers at first, then use the wrenches.

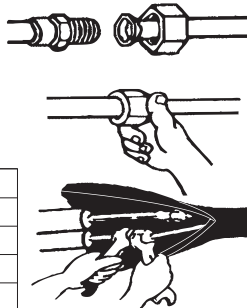

Model	Pipe size	Torque	Nut width
7,9,12,18K	Liquid Side (\varnothing 6 or 1/4 inch)	1.8kg.m	17mm
22,24K	Liquid Side (\varnothing 10 or 3/8 inch)	3.5kg.m	22mm
7,9K	Gas Side (\varnothing 10 or 3/8 inch)	3.5kg.m	22mm
12,18K	Gas Side (\varnothing 12 or 1/2 inch)	5.5kg.m	24mm
22,24K	Gas Side (\varnothing 16 or 5/8 inch)	7.5kg.m	27mm

For T3 climate kind models, 18K and 24K Liquid Side is \varnothing 6 (or 1/4 inch).

Identification of parts

Operating and Display

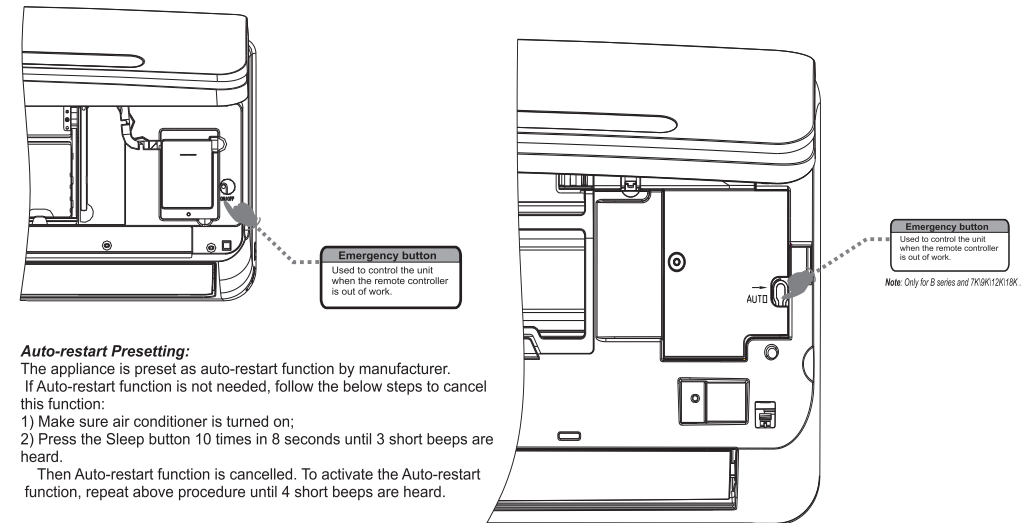
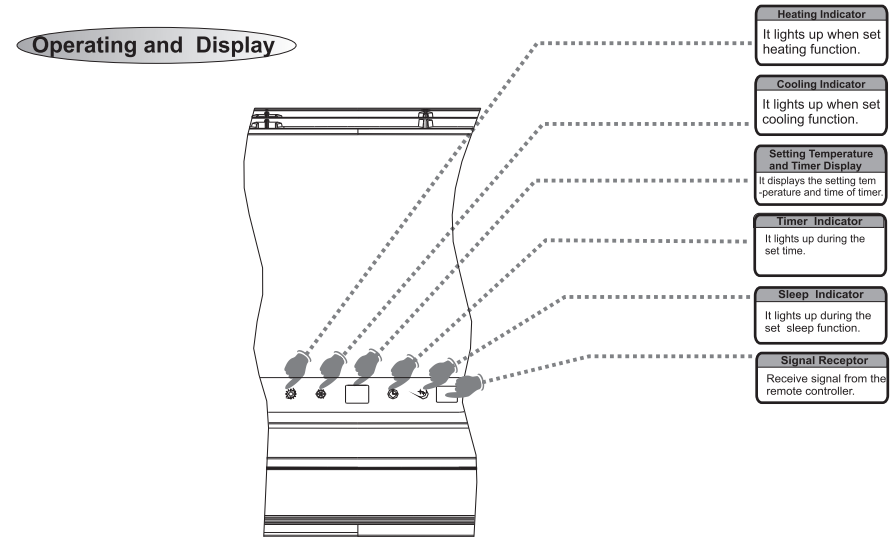

Auto-restart Presetting:

The appliance is preset as auto-restart function by manufacturer. If Auto-restart function is not needed, follow the below steps to cancel this function:

- 1) Make sure air conditioner is turned on;
- 2) Press the Sleep button 10 times in 8 seconds until 3 short beeps are heard.

Then Auto-restart function is cancelled. To activate the Auto-restart function, repeat above procedure until 4 short beeps are heard.

☑ The shape and position of the switches and indicators may vary from different models, but their function are similar.

Remote controller

Remote controller

The remote controller transmits signals to the system.

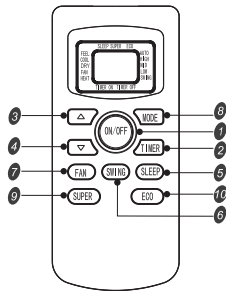

- 1 ON/OFF button**
Used to start and stop operation when pressed.
- 2 TIMER button**
Used to select TIMER operation.
- 3 UP button (TOO COOL button)**
Used to increase the set room temperature and time.
- 4 DOWN button (TOO WARM button)**
Used to decrease the set room temperature and time.
- 5 SLEEP button**
Used to set or cancel sleep mode operation. In cooling or heating mode, press "SLEEP" button more than 10 times in eight seconds, open or close auto-restart function.

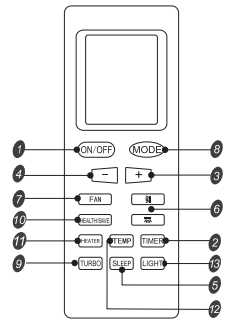

- 6 VANE control button** (Only some models are used)
Vane control/Swing
- 7 FAN SPEED control button**
Used to select the indoor fan motor speed: Auto, High, Mid and Low.
- 8 MODE button**
Used to select the type of operation mode: Feel, Cooling, Dry, Fan and Heating(Only for Heat Pump).
- 9 SUPER(TURBO) button**
Used to set or cancel superstrong mode operation.
- 10 ECO(HEALTH/SAVE) button** (Only some models are used)
Used to set or cancel economic mode operation.

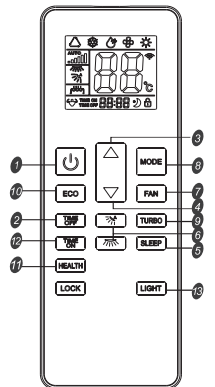

- 11 HEATER button** (Only some models are used)
- 12 TEMP button** (Only some models are used)
Celsius to Fahrenheit
- 13 LIGHT button**
Lamp light display

Note: Each mode and relevant function will be further specified in following pages.
The remote controller is general type, some keys are printed on the remote controller, but do not have this function.

Installation instructions

Indoor unit installation

1. Installing the Mounting Plate

- Decide an installing location for the mounting plate according to the indoor unit location and piping direction.
- Keep the mounting plate horizontally with a horizontal ruler or dropping line.
- Drill holes of 32mm in depth on the wall for fixing the plate.
- Insert the plastic plugs to the hole, fix the mounting plate with tapping screws.
- Inspect if the mounting plate is well fixed. Then drill a hole for piping.
- Distance from floor should be over 2500mm

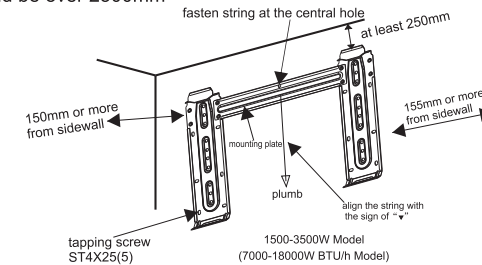

Note: The shape of your mounting plate may be different from the one above, but installation method is similar.

2. Drill a Hole for Piping

- Decide the position of hole for piping according to the location of mounting plate.
- Drill a hole on the wall. The hole should tilt a little downward toward outside.
- Install a sleeve through the wall hole to keep the wall tidy and clean.

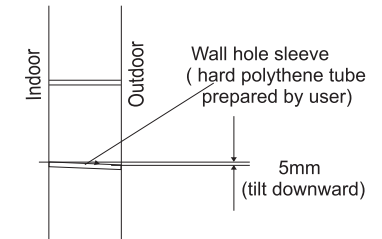

3. Indoor Unit Piping Installation

- Put the piping (liquid and gas pipe) and cables through the wall hole from outside or put them through from inside after indoor piping and cables connection complete so as to connect to outdoor unit.
- Decide whether saw the unloading piece off in accordance with the piping direction. (as shown below)

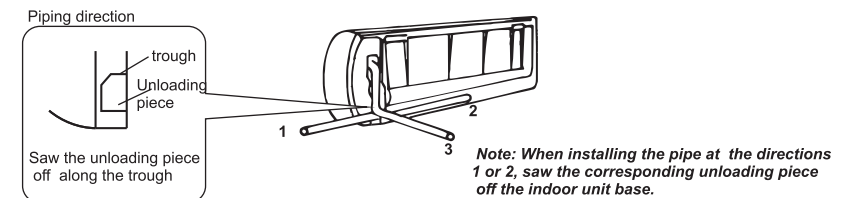

- After connecting piping as required, install the drain hose. Then connect the power cords. After connecting, wrap the piping, cords and drain hose together with thermal insulation materials.

Installation instructions

Connecting of the Cable

Wiring between the indoor and outdoor units:

- 1) Remove the PCB cover from the indoor unit;
- 2) Refer to the wiring diagram attached to indoor unit when connecting cords to indoor unit terminals;
- 3) Reinstall the PCB cover. Be sure that the side **B** are at outside.

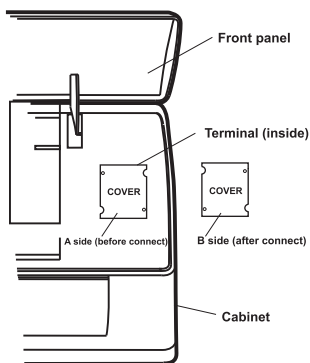

Select the best location

Location for Installing Indoor Unit

- Where there is no obstacle near the air outlet and air can be easily blown to every corner.
- Where piping and wall hole can be easily arranged.
- Keep the required space from the unit to the ceiling and wall according to the wiring diagram.
- Where the air filter can be easily removed.
- Keep the unit and remote controller 1m or more apart from television, radio etc.
- To prevent the effects of a fluorescent lamps, keep as far as possible.
- Do not put anything near the air inlet to obstruct it from air absorption.
- Where there is strong enough to bear the weight and is not tend to increase operation noise and vibration.

Installation Diagram

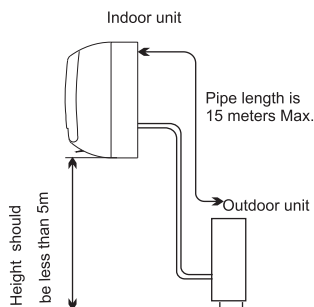

Location for Installing Outdoor Unit

- Where it is convenient to install and well ventilated; avoid installing it where flammable gas could leak.
- Keep the required distance apart from the wall.
- Keep the outdoor unit away from a place of greasy dirt, vulcanization gas exit or high salty seashore.
- Avoid installing it at the roadside where there is a risk of muddy water.
- A fixed base where is not subject to increasing operation noise.
- Where there is not any blockage for air outlet.

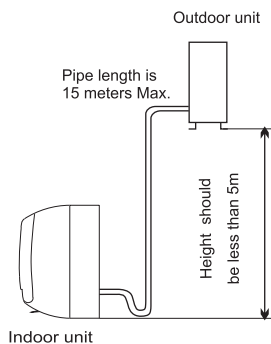

Remote controller

Remote controller

How to Insert the Batteries

Remove the battery cover according to the arrow direction.

Insert new batteries making sure that the (+) and (-) of battery are matched correctly.

Reattach the cover by sliding it back into position.

Note:
Use 2 LR03 AAA(1.5volt) batteries. Do not use rechargeable batteries.
Replace batteries with new ones of the same type when the display becomes dim.

Storage and Tips for Using the Remote Controller

Keep the remote controller safe and dry while not using.

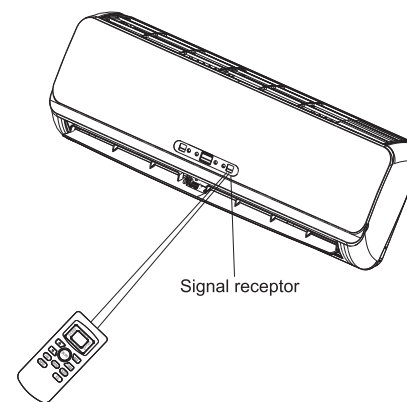
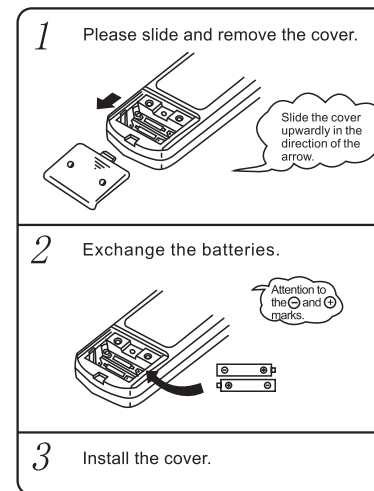

How to Use

To operate the room air conditioner, aim the remote controller to the signal receptor. The remote controller will operate the air conditioner at a distance of up to 7m when pointing at signal receptor of indoor unit.

Operation instructions

FEEL mode operation procedure

Operates by selecting automatically the operation mode(HEATING,DRY,FAN,COOLING)depending on the room temperature at starting.

With the remote controller pointing toward the air conditioner.

Turning on

Press **ON/OFF** button, when the appliance receives the signal, the RUN indicator of the indoor unit lights up.

1

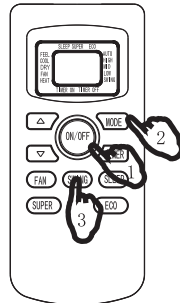

When the unit is not at FEEL mode.

Selecting FEEL mode

Press the MODE select button.
Move the MODE to the FEEL position.

2



Operation mode and temperature are determined by indoor temperature

Indoor temperature	Operation mode	Target temperature
Less than 20 °C	HEATING FOR HEAT PUMP TYPE FAN FOR COOL ONLY TYPE	23 °C
20 °C~26 °C	DRY	18 °C
Over 26 °C	COOLING	23 °C

Air temperature adjustment is possible even during FEEL operation. There are 6 levels of adjustment possible with the **▲** button or the **▼** button.

Setting temperature

Press the **▲** button or the **▼** button.
When the **▲** button is pushed,the temperature increases 1 °C .
After temperature add 2 °C ,the indicator did not change.
When the **▼** button is pushed,the temperature reduces 1 °C .
After temperature reduces 2 °C ,the indicator did not change.

3

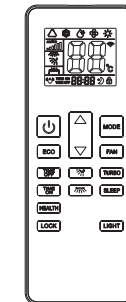

NOTE

Air is not blown out during operation.
Change mode during operation,sometimes it can not run at once.

The operation of the AUTO mode can be performed by only pressing the ON/OFF button the next time.



- If you don't like the content of FEEL mode operation, change to HEATING,DRY or COOLING than FEEL.

Installation instructions

Installation diagram

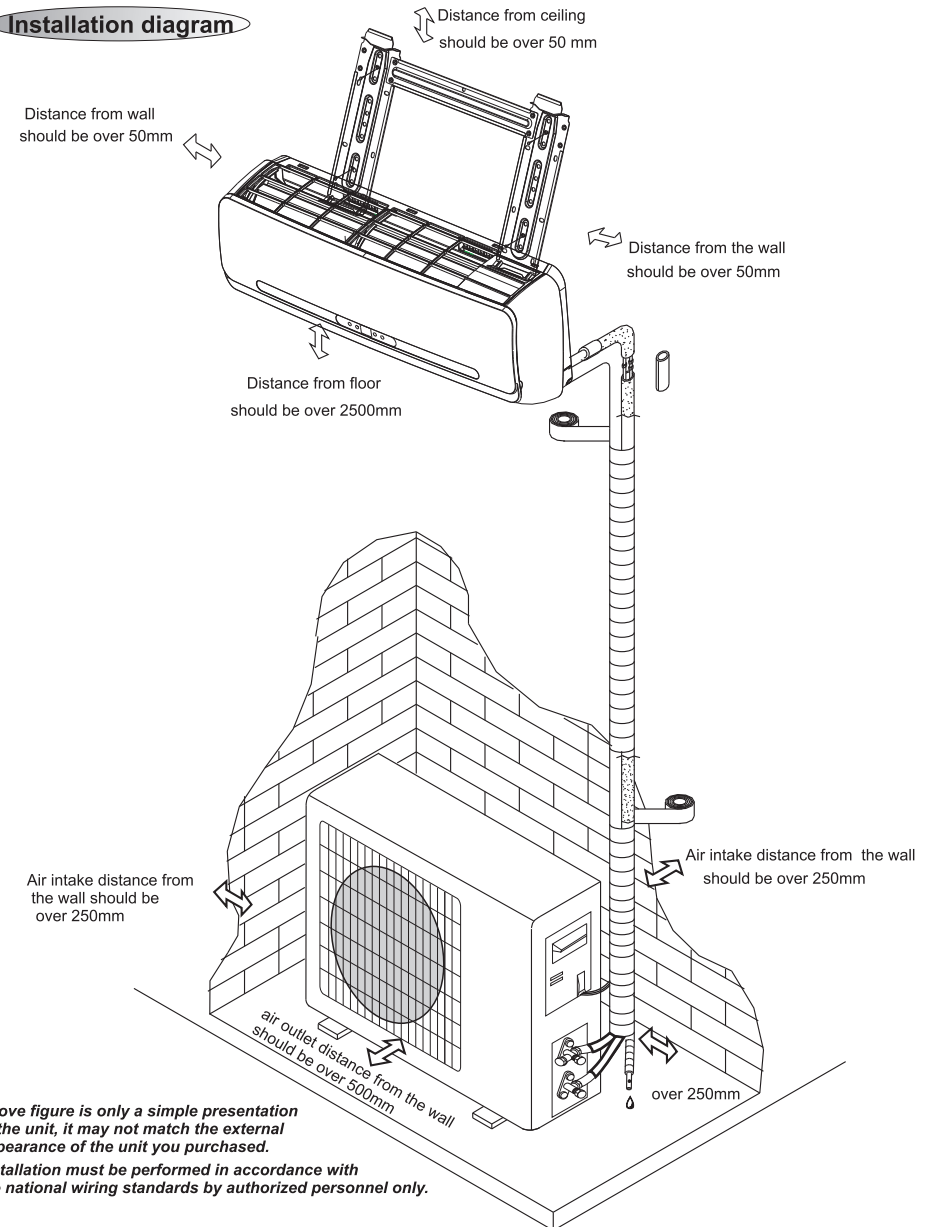







NOTE

- Above figure is only a simple presentation of the unit, it may not match the external appearance of the unit you purchased.
- Installation must be performed in accordance with the national wiring standards by authorized personnel only.

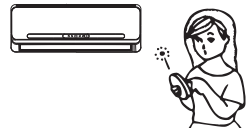
Troubleshooting

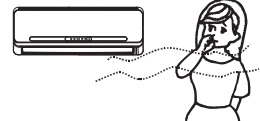
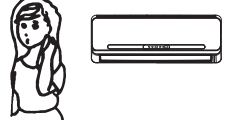
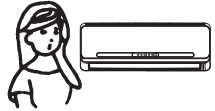
The following cases may not always be a malfunction, please check it before asking for service.

Trouble	Analysis
Does not run 	<ul style="list-style-type: none"> If the plug is not properly plugged. If batteries in the remote controller exhausted. If the protective device works to protect the appliance. If the protector trip or fuse is blown.
No cooling or heating air 	<ul style="list-style-type: none"> Are the intakes and outlets of the air conditioner blocked? Is the temperature set properly? Is the air filter dirty?
Ineffective control 	<ul style="list-style-type: none"> If strong interference (from excessive static electricity discharge, power supply voltage abnormality) presents, operation will be abnormal. At this time, disconnect from the power supply and connect back 2-3 seconds later.
Does not operate immediately 	<ul style="list-style-type: none"> Changing mode during operation, 3 minutes will delay.
Peculiar odor 	<ul style="list-style-type: none"> This odor may come from another source such as furniture, cigarette etc, which is sucked in the unit and blows out with the air.
A sound of flowing water 	<ul style="list-style-type: none"> Caused by the flow of refrigerant in the air conditioner, not a trouble. Defrosting sound in heating mode.
Cracking sound is heard 	<ul style="list-style-type: none"> The sound may be generated by the expansion or contraction of the front panel due to change of temperature.
Spray mist from the outlet 	<ul style="list-style-type: none"> Mist appears when the room air becomes very cold because of cool air discharged from indoor unit during COOLING or DRY operation mode.
The compressor indicator (red) lights on constantly, and indoor fan stops.	<ul style="list-style-type: none"> The unit is shifting from heating mode to defrost. The indicator will light off within ten minutes and returns to heating mode.

Operation instructions

TIMER mode

It is convenient to set the timer on with **TIMER** button when you go out in the morning to achieve a comfortable room temperature at the time you get home. You can also set timer off at night to enjoy a good sleep.

Timer setting

When the remote controller is off, press the **TIMER** button to set a switch-on timer, press again, the setting cancel.



When the remote controller is on, press the **TIMER** button to set a switch-off timer, press again, the setting cancel.

Press UP and DOWN button to set time.
Time setting is 30-minutes units.



Note: After setting the timer, check that **TIMER INDICATOR** lamp of the indoor unit lights.

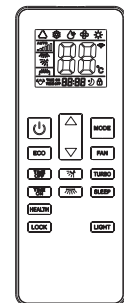

Maintenance

Front panel maintenance

1 Cut off the power supply

Turn off the appliance first before disconnecting from power supply.

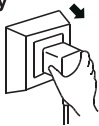

2

Grasp position "a" and pull outward to remove the front panel.

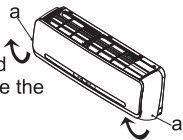

3 Wipe with a soft and dry cloth.

Use lukewarm water (below 40°C) to clean if the appliance is very dirty.



Use a dry and soft cloth to clean it.

4 Never use volatile substance such as gasoline or polishing powder to clean the appliance.



5 Never sprinkle water onto the indoor unit



Dangerous! Electric shock!

6 Reinstall and shut the front panel.

Reinstall and shut the front panel by pressing position "b" downward.

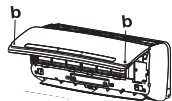

Air filter maintenance

It is necessary to clean the air filter after using it for about 100 hours.

Clean it as follows:

1 Stop the appliance and remove the air filter.

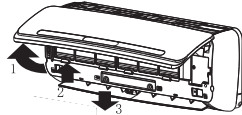

1. Open the front panel.
2. Press the handle of the filter gently from the front.
3. Grasp the handle and slide out the filter.

2 Clean and reinstall the air filter.

If the dirt is conspicuous, wash it with a solution of detergent in lukewarm water. After cleaning, dry well in shade.



3 Close the front panel again.

- ☑ Clean the air filter every two weeks if the air conditioner operates in an extremely dusty environment.

Protection

Operating condition

The protective device maybe trip and stop the appliance in the cases listed below.

HEATING	Outdoor air temperature is over 24°C
	Outdoor air temperature is below -7°C
	Room temperature is over 27°C
COOLING	Outdoor air temperature is over *43°C
	Room temperature is below 21°C
DRY	Room temperature is below 18°C

* For Tropical (T3) Climate condition models, the temperature point is 52°C instead of 43°C.

If the air conditioner runs in COOLING or DRY mode with door or window opened for a long time when relative humidity is above 80%, dew may drip down from the outlet.

Noise pollution

- Install the air conditioner at a place that can bear its weight in order to operate more quietly.
- Install the outdoor unit at a place where the air discharged and the operation noise would not annoy your neighbors.
- Do not place any obstacles in front of the air outlet of the outdoor unit lest it increases the noise level.

Features of protector

1 The protective device will work at following cases.

- Restarting the unit at once after operation stops or changing mode during operation, you need to wait 3 minutes.
 - Connect to power supply and turn on the unit at once, it may start 20 seconds later.
- #### 2
- If all operation has stopped, press **ON/OFF** button again to restart.
 - Timer should be set again if it has been canceled.

Inspection

After using for long time, the air conditioner should be inspected on the following items.

- Overheat of the power supply cord and plug or even a burned smell.
 - Abnormal operating sound or vibration.
 - Water leakage from indoor unit.
 - Metal cabinet electrified.
- ☑ Stop the air conditioner if above trouble occurs. It is advisable to have a detail inspection after using it for 5 years even if none above occurs.

Features of HEATING mode

Preheat

At the beginning of **HEATING** operation, the airflow from indoor unit is discharged 2-5 minutes later.

Afterheat

After the finishing of **HEATING** operation, the airflow from indoor unit is discharged 2-5 minutes.

Defrost

In **HEATING** operation the appliance will defrost (de-ice) automatically to improve efficiency. This procedure usually lasts 2-10 minutes. During defrosting, fans stop operation. After defrosting completes, it returns to **HEATING** mode automatically.

Note: Heating is NOT available for cooling only air conditioner models.